

## K-2 and K-6 Flat Grate with 6 Inch Stack

Through these instructions we will try to guide you on a step by step procedure for installing, adjusting and operating of your new KEYSTOKER stoker boiler unit.

**Selection of location.** Keystoker boilers are available with fire door on the right or left side. When you stand at the stoker end of the boiler and look directly over top of boiler toward stack end, you may choose to have a fire door on the right or left side of boiler. Selecting a position to make this door accessible is important. When door side must be placed toward a wall, 30" clearance is recommended for easy fire and ash door access. Clearance from wall at stack end should be 18" to permit removal of water heating coil if necessary. Clearance on blank and hopper sides should be 6".

**Setting up boiler.** Place boiler in desired position. We strongly recommend placing steel shims or bricks under each corner of boiler to allow an air space, to prevent moisture from accumulating and rusting base of boiler. Using a level, plumb stoker end of the boiler, adding steel shims as necessary to plumb the stoker end of the boiler. Failure to do this will change pitch on stoker unit and may have adverse effects when burning coal. Again with level, check top of boiler from side to side, adding shims as necessary to level boiler. Do not place shims completely under boiler. Allow 1" to 2" of shims to extend out from under the boiler. Shims will then be used as a base to rest insulated jacket upon.

**Supply & return piping system.** The top of you boiler has at least 4 openings. The largest opening is the feed line to your radiation. Since this outlet has a drop tube welded inside the boiler, you must use it for your radiation supply line. Even thou it may be necessary to bush down to a smaller size, we recommend starting with 1 1/4" pipe and installing a 1 1/4" x 1 1/4" x 1" tee in supply line to be used for a by-pass loop. (See Installation Diagram Pg6). You may now make your piping connections from feed outlet on boiler to flow valve.

You may use either of the large openings on the bottom of the stack end of the boiler as your return. Select the side that will allow convenient access to the circulator for future servicing. Install return piping and circulator, again referring to (Installation Diagram Pg 6) for location of by-pass loop. Your 1 1/4" x 1 1/4" x 1" tee must be installed below circulator.

Install by-pass loop as per (Installation Diagram) with 1" pipe size. Place a tee 1' x 1/2" F x 1" in by-pass loop to allow installation of immersion well for the 4006B Honeywell Hi Limit control to extend into full water flow.

## K-2 and K-6 Flat Grate with 6 Inch Stack

Over 50 years of installation experience has proven to us that the above mentioned by-pass loop is absolutely necessary for optimum performance of your heating system (see Diagram Pg5).

Install a boiler drain valve in the other large opening at bottom of boiler. (See Diagram pg 7).

**Boiler fill and domestic water piping.** Refer to Installation Diagram Pg 6; install 1/2" male adaptors in both fittings on domestic water coil. Install a 1/2" male adaptor in the 1/2" fitting on top of boiler to be used for a boiler water fill.

**NOTE:** Before proceeding with connections for piping of boiler feed and domestic water, INSTALL stack end of insulated steel jacket NOW. Then you may proceed with completion of domestic piping and installation of necessary valves. (See Diagram Pg 6).

Install a domestic water mixing valve, we recommend a Honeywell AM-1 series not included with boiler install as per manufactures instructions (See Diagram Pg 6).

If an automatic fill valve is desired, install as per manufacture's instructions.

Install a PH 5 expansion tank on the domestic mixed water line as per manufactures instructions (See Diagram Pg 6).

**Installation and piping of accessories:** A 3/4" 30 lb. AMSE approved relief valve must be installed in 3/4" fitting on top of boiler, turning discharge to the side and hard pipe it to 3" above floor (See Diagram Pg7).

Install altitude gauge (temperature/ pressure gauge) (See Diagram Pg 7).

Connect expansion tank directly to remaining fittings on top of the boiler, NOT to any other part of the heating system. Install a 1/2" ball valve in pipe going to expansion tank with direction marker on valve pointing toward the expansion tank. (See Diagram Pg 7).

Install immersion well for low water cutoff in 3/4" fitting on side of boiler above fire door in lower hole closest to unit end of boiler (See Diagram Pg5).

Install immersion well for triple aquastat relay in 3/4" fitting on side of boiler above fire door. (See Diagram Pg 7).

## K-2 and K-6 Flat Grate with 6 Inch Stack

Place fire door into boiler opening and secure by tightening screws in frame of fire door. Seal fire door with high temp. silicone or furnace cement. Install spring handle on fire door handle by bending spring handle open and put it through hole in handle on fire door and squeezing it closed.

**Jacket and stoker installation:** Install hopper end of jacket, then blank side, then fire door side, secure with #8 x 1 sheet metal screws provided. Install jacket top and secure with #8 x 3/8 sheet metal screws.

Stoker units are shipped entirely assembled. Lift stoker into opening, bottom of a stoker has a 1/4" rod welded in place which must go inside the stoker opening. Place a thick smear of furnace cement or high temp. Silicone on flange of stoker and tilt into place, securing with 3/8 x 1 1/4 machine screws, washers, and nuts as provided.

Set hopper into place. The hopper bottom should lap over stoker throat approximately 1". Since one hopper is use for several size stokers, it may be necessary to trim the opening. Bend flange down to fit inside throat of stoker – be sure mechanism is free to operate.

**Control installation and electrical wiring:** Install triple aquastat into its well being careful not to kink the thin capillary tube. Install low water cutoff onto its well. Screw timer to jacket next to the triple Aquastat (See Diagram Pg 6).

Install 4006B hi limit into well in by-pass loop. (See Diagram Pg 6).

Your stoker must be on its own circuit. From main breaker to boiler use 12-2 wire with ground on a 20 amp breaker. Follow wiring diagram and any applicable UL and local code

**Stack pipe and draft control installation:** Stack pipe may now be connected from boiler to chimney, using as few elbows as possible. If stack pipe must be reduced in size, reduce stack at thimble. It is important to run full size stack from boiler to chimney thimble. Install barometric draft controls in first full section of stack closest to boiler. Follow instructions packed with draft control, making sure the draft control bearing are level and face of draft control is perpendicular to floor. Stack pipe must be 18" from any combustible.

## K-2 and K-6 Flat Grate with 6 Inch Stack

**Initial start up:** Fill system by opening boiler feed valve. Open air vents on radiation one at a time until air is removed from system. Normal operating pressure on most heating systems is between 10 and 20 PSI. Automatic fill valves are factory set at 12 PSI. If an automatic fill valve is not used, then boiler feed valve must remain in normally closed position.

Open valve supplying water to domestic hot water coil, this valve must remain in the normally open position.

Open valve supplying water to expansion tank, this valve must remain in the normally open position.

**Starting coal fire:** DO NOT USE ACCELERANT SUCH AS: as gasoline, lighter fluid, or kerosene, etc. Use dry coal only. Put coal in hopper. By reaching through fire door, pull coal down to cover entire grate. Crush several charcoal briquettes into smaller pieces, crumble newspaper and dig it through the coal, so it touches the grate. Lay charcoal on top of newspaper. Turn switch on. When charcoal turns red, place a few hands full of coal on top of charcoal. If fire moves toward bottom of grate before fire is established, coal feed can be slowed down by turning white nut CCW.

**After starting coal fire:** Allow stove and chimney to warm up. Insert draft gauge through pre-drilled hole in upper portion of fire door. Open air shutter (located on bottom of scroll between stoker motor and gear box about 1/2"). Then with stoker motor running and feeding coal adjust the barometric damper until draft gauge reads (-.02). If draft is less than a (-.02) draft with the barometric damper closed you must close the air shutter (between gear box & stoker motor) a little and recheck. Repeat until you obtain a (-.02) draft. If the draft is higher than (-.02) you must adjust the barometric draft regulator. Move the weight on barometric regulator left or right to obtain the (-.02) Recheck the draft until you obtain a (-.02).

**Initial coal feed:** Advance white nut all the way forward. Then turn it counter clockwise 4 or 5 turns if burning rice coal, if burning buckwheat coal turn coal feed, back 3 or 4 turns. When boiler is running for about an hour under full load grates should have about 2" of dead ash on them before falling into the ash pan.

As prices of fuel continues to increase –KEYSTOKER – continues to improve and make its product more fuel efficient.

## K-2 and K-6 Flat Grate with 6 Inch Stack

To obtain a more complete burn out of coal, the combustion blower motor runs continuously it is attached to the stoker unit. **THIS MOTOR IS DESIGNED FOR CONTINUOUS RUN.**

During summer operation, the small combustion motor will force a small amount of air through grates at all times, which will cause the ash to become like powder. It also prevents the fire from going out. At the same time, it reduces the size of fire bed to approximately 1 ½” to 2” which will prevent boiler water from becoming overheated.

Proper sizing of fire is obtained by turning white nut on feed control arm. Clockwise (CW) for more coal feed and Counterclockwise (CCW) for less coal feed.

Location and final placement for white nut will be determined by size of coal you purchase. For rice coal, white nut might be turned down 5 turns for maximum setting, whereas for buckwheat coal, white nut might only be turned down 4 turns from maximum setting.

During winter operation, hot coals should never be pushed off end of grate. This indicated that coal feed needs to be reduced (CCW) or if during winter operation; fire bed is too small, turn red nut (CW).

After coal feed adjustment is completed, if during summer, the water is too hot...**DO NOT ADJUST COAL FEED.** Reduce timer only. If fire goes out...**DO NOT ADJUST COAL FEED.** Increase timer only.

# Side View

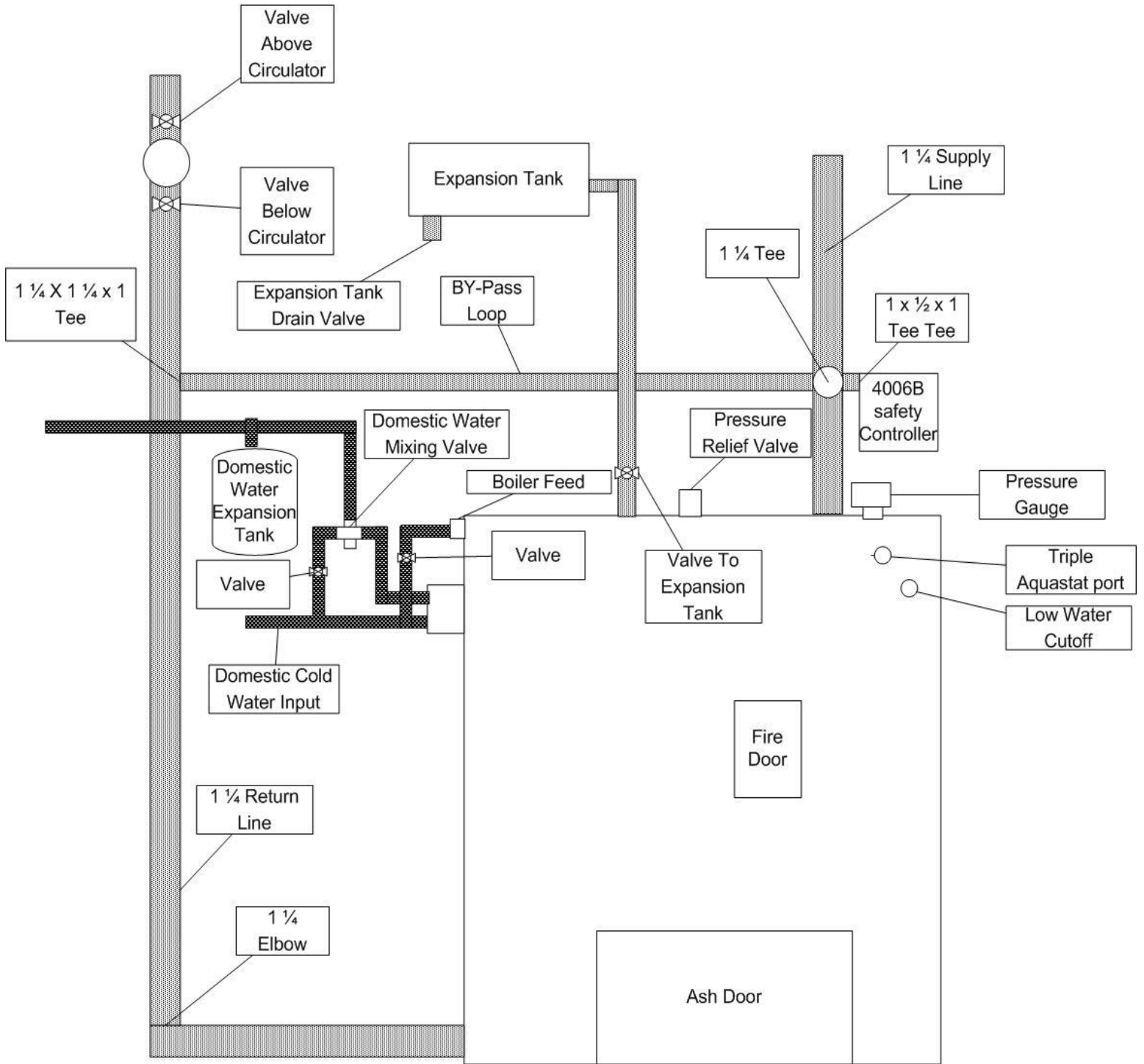

# Top View

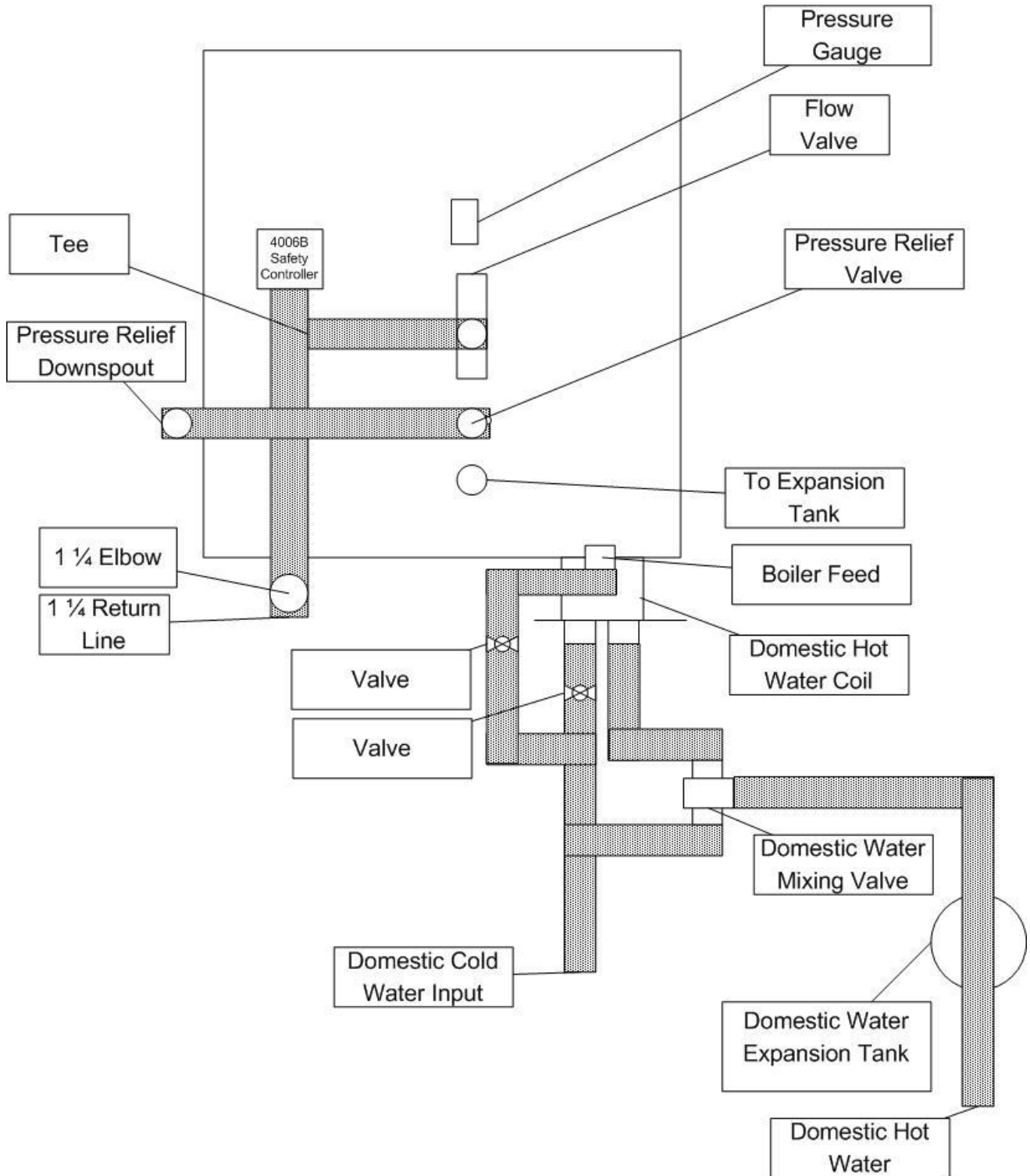

K-2 and K-6 Flat Grate with 6 Inch Stack

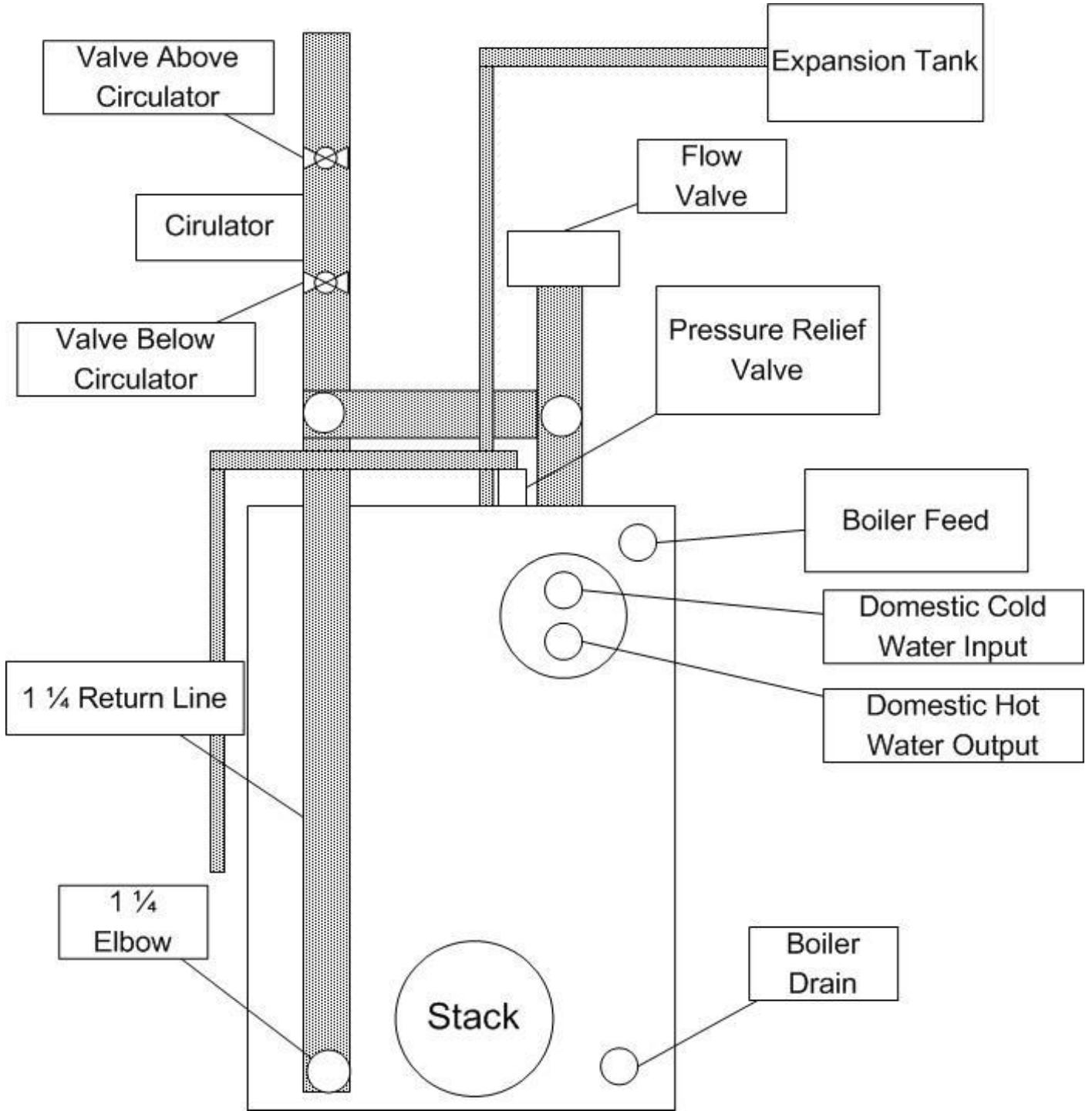



## K-2 and K-6 Flat Grate with 6 Inch Stack

### DIAGRAM (1)

Shows what fire should look like when thermostat calls for heat for extended period:

- A. Unburned fresh coal supply from coal hopper
- B. Burning Coals
- C. Ash on lower end of grate (around 2") the actual length of burning coals will vary as heat demand increases or decreases. If

burning coals fall off grate, reduce coal feed by turning white adjustment nut in a counter clock-wise direction 1 or 2 full turns. Wait at least 1 hour before making any more adjustments.

When thermostat is calling for heat, the gear motor will be in continuous run, but if the fire bed remains small, increase the coal feed by turning white adjustment nut clock-wise.

Under normal draft conditions, when fire bed has reached its maximum length (with 2" of ash) flames should be touching top of interior stove plate. If flame is not reaching top of stove:

- A. Fire bed may be too thick.  
Reduce coal feed.  
Hopper end of stove is not plumb.  
Burrs may be stuck on grate, scrape grate until it is smooth.  
Not enough air flow, adjust air intake shutter on combustion motor (see check draft).

### DIAGRAM (2)

Show what fire size should look like when thermostat has not called for heat for extended periods:

- A. Unburned fresh coal supply from hopper.
- B. Burning coal (about 1-1 1/2" to 2") (low flames).
- C. Ash on lower end of grate

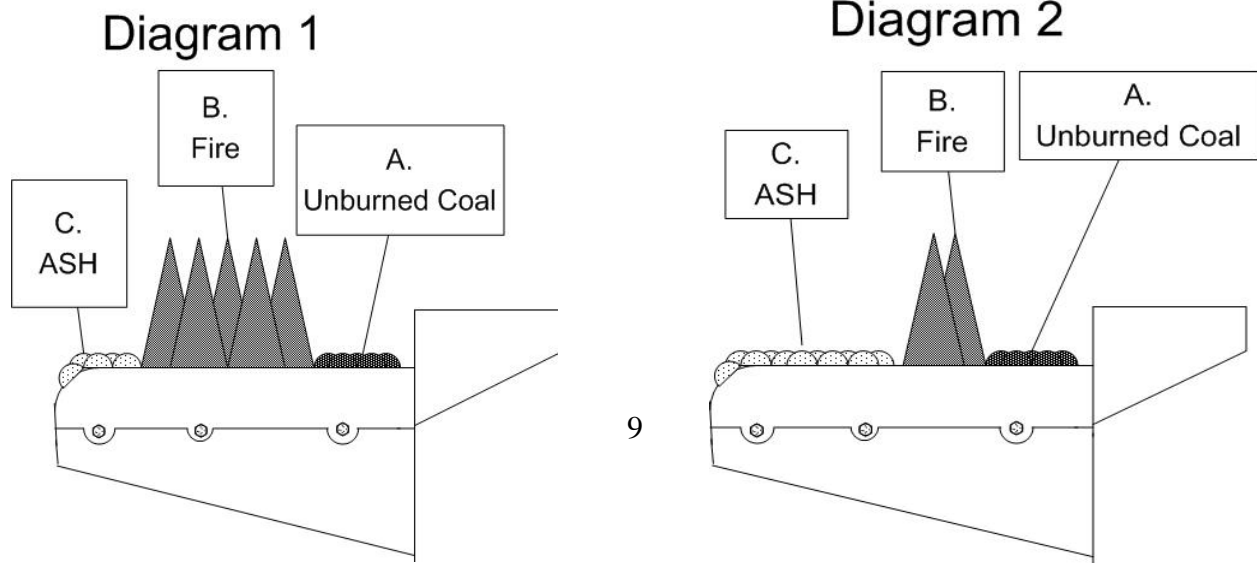

## K-2 and K-6 Flat Grate with 6 Inch Stack

**PUSHER BAR:** Moves in a reciprocating motion. Activated by cam on gear motor to force coal from hopper onto grate. Also pushes ashes off grate into ash pan. Length of stroke is adjustable by turning white coal feed adjustment nut.

**WHITE COAL FEED ADJUSTMENT:** Turn clockwise for more coal feed, Turn counterclockwise for less coal feed.

**NYLON ADJUSTING SCREWS:** To eliminate metal on metal contact. There are 8 nylon screws on the pusher bar, 4 on each side. The 4 nylon screws pictured on diagram are used to adjust the amount of sideward movement of pusher bar. When nylon screws are properly aligned, the pusher bar will slide in and out freely and have only a slight sideward movement.

**NYLON CAM:** located on gear motor. To give reciprocating motion to pusher bar shown on next page

**Air INTAKE ADJUSTMENT SHUTTER:** adjusts amount of air flow through fire. Shown on next page

**GEAR MOTOR:** The drive shaft turns approximately 1RPM. The nylon cam on drive shaft will, when moving inward, force coal from hopper onto grate. When withdrawing, will allow coal to fall in front of pusher bar for preparation of next inward stroke. The gear motor will only run when activated by a call for heat from thermostat or when timer turns it on.

**COMBUSTION MOTOR:** Combustion motor will run all the time to force air through holes in grate to burn coal hotter. The constant running of motor will assure the maximum amount of heat is gained and will aid in a more complete burning of coal. The motor has an adjustable air shutter for regulating air flow through fire.

### **Pusher Bar**

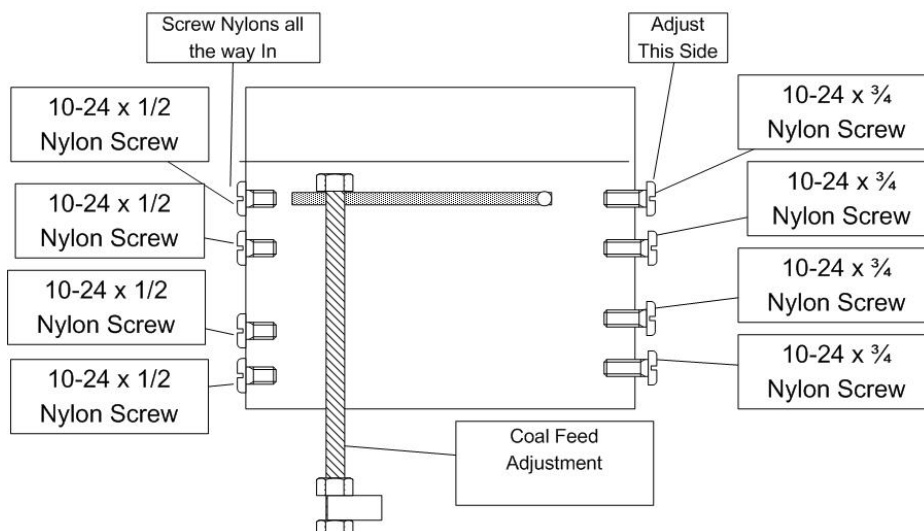

## K-2 and K-6 Flat Grate with 6 Inch Stack

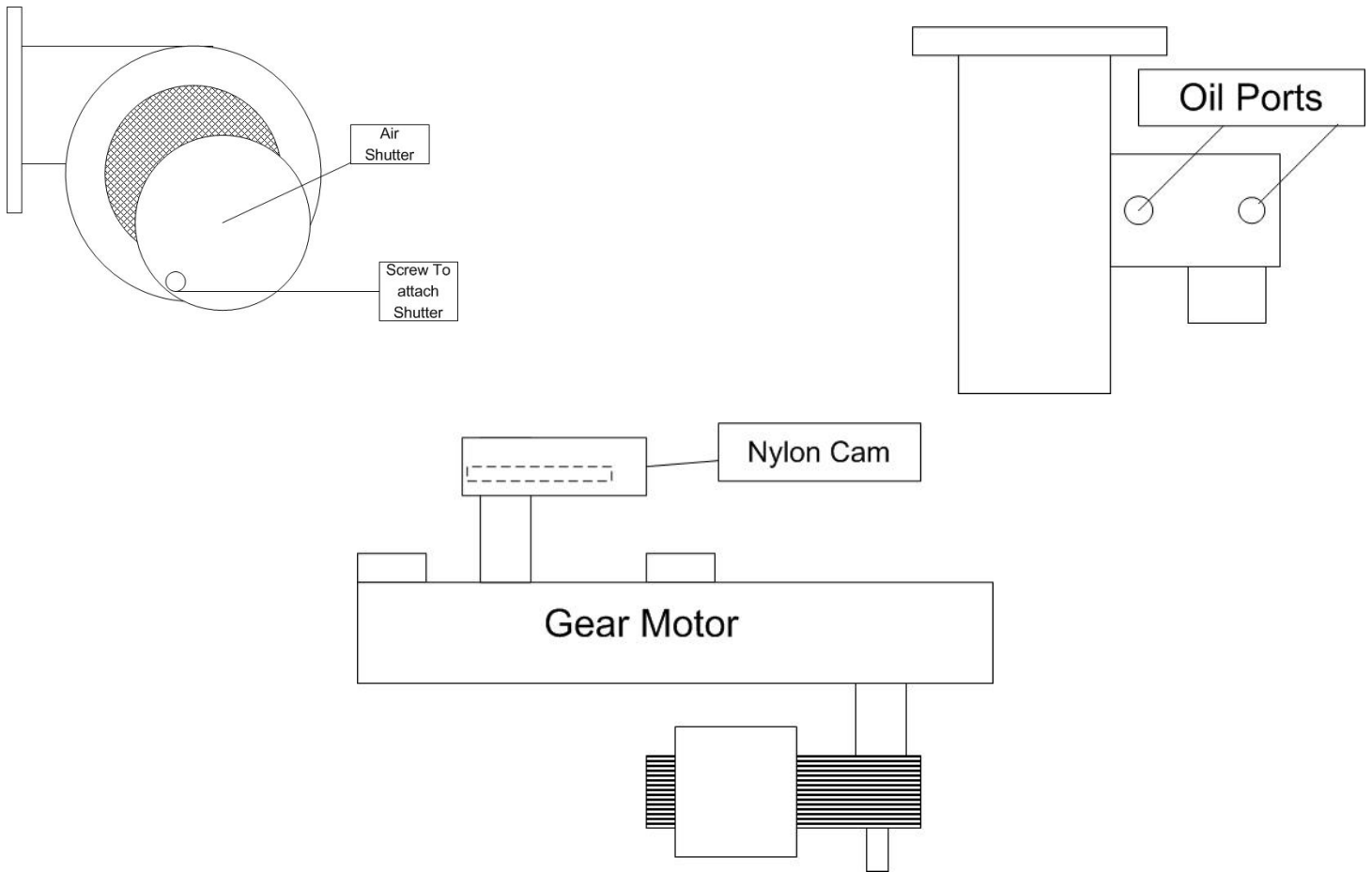

### **TIMER**

Unless your stove had been a special order, it will be equipped with our patented flatgrate stoker unit and a timer. The timer is shown on the next page.

The purpose of a timer is to maintain a minimum fire when thermostat is not calling for heat.

The timer is factory set to run 1 ½ minutes every 10 minutes. The timer activates the gear motor, which will cause the pusher bar to move in a reciprocating motion, forcing coal onto grate.

The timer has a large yellow wheel that makes 1 revolution every 30 minutes. Pins can be inserted or removed from yellow wheel. Each pin equals about 15 seconds, if needed, extra pins can be added to the present groups of pins or pins can be inserted anywhere in yellow wheel.

## K-2 and K-6 Flat Grate with 6 Inch Stack

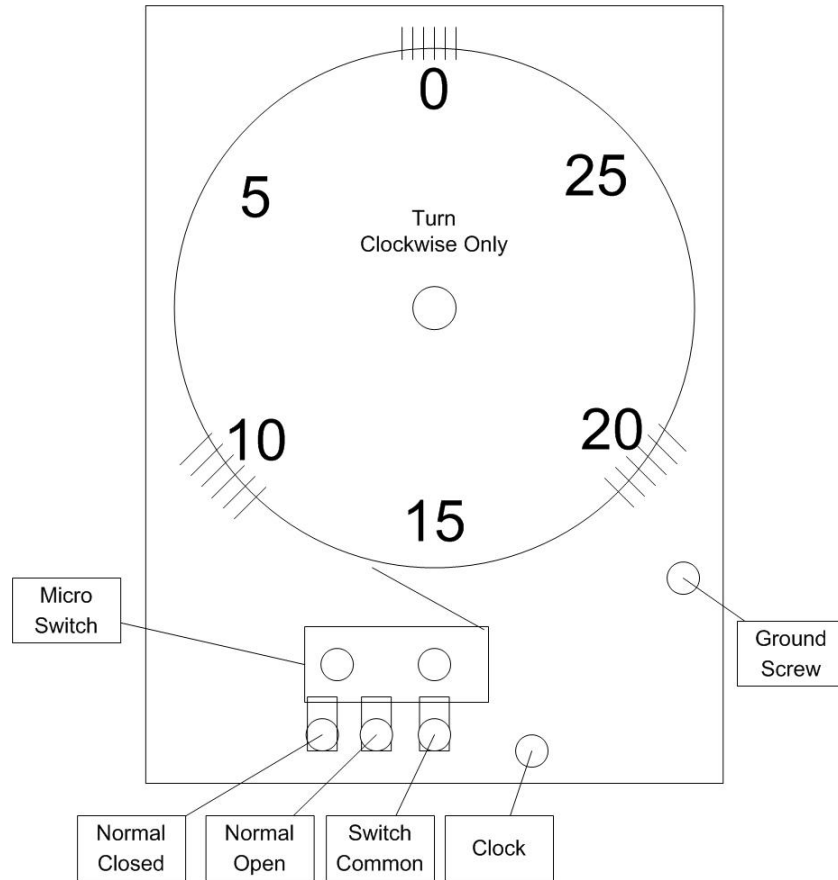

This section **ONLY** pertains to periods when thermostat is not calling for heat. If the fire goes out, you will have to add more pins to timer **OR** increase coal feed.

The burning coals should be the width of the grate and about 1 ½" to 2" in length. If the burning coals get any less than 1 ½" the fire may go out. **SOLUTION:** Increase coal feed.

A weak draft can also cause the fire to go out, if fire appears to be very dull, add as many extra pins to timer as needed, until fire stays lit.

### IF FIRE STAYS LIT, BUT STOVE IS TOO HOT

If convection blower cycles on and off often and produces too much heat, either the fire bed is too long or timer is running too long. If you reduce coal feed or remove timer pins, do not make radical changes. Reduce coal feed 1 or 2 turns **OR** remove 1 pin from timer. Then wait several hours before making any more reductions. A sudden radical change may be too much and cause fire to go out.

Once the coal feed and timer are set and fire stays lit, without convection blower running too much, it is usually not necessary to make any more changes.

## K-2 and K-6 Flat Grate with 6 Inch Stack

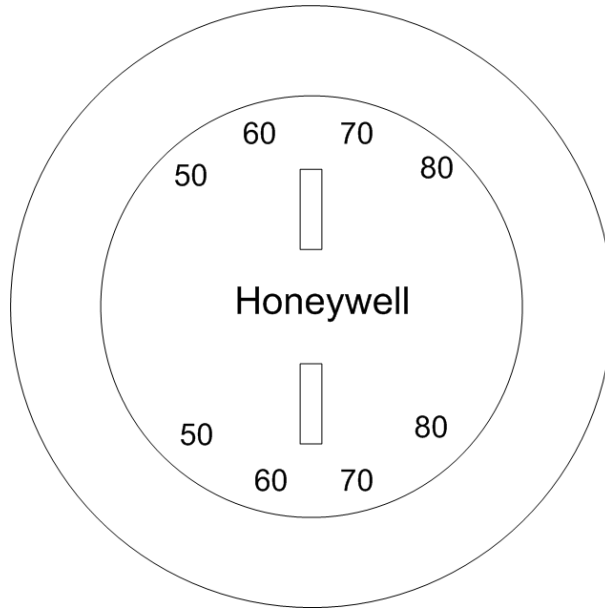

### **THERMOSTAT**

Top pointer is to be set at warmth desired in home. Bottom pointer is the present temperature in room. When temperature in **room** (bottom pointer) falls below desired room temp. (top pointer), this will send a signal to the relay control to activate gear motor to push fresh coal onto grate.

### **HOW TO REMOVE OR REPLACE GEAR MOTOR**

**TO REMOVE GEAR MOTOR:** FIRST...Pull power cord pug from 115V outlet. Remove Coal from hopper. Remove 10-24 machine screw and then remove protective cage. Disconnect both blue wire nuts marked. Remove both 10-24 machine screws from mounting bracket. Slide gear motor out of its track toward you, pusher bar will also come out with gear motor.

While pusher bar is out of its chute, clean chute area and remove any obstructions. Check nylon screws on pusher bar (2 on each side) for wear or breakage. (Replace if necessary)

Slide pusher bar in and out of chute (should move freely) check for sideward movement.

Adjust nylon screws on right side to allow only a slight sideward movement.

**TO REPLACE GEAR MOTOR:** -remove (4) 10-32 machine screws that hold gear motor onto mounting bracket. Before removing gear motor from bracket,

## K-2 and K-6 Flat Grate with 6 Inch Stack

look at position of gear motor; install new motor in exact same position before reinstalling screws. Then reverse procedures and reinstall.

When replacing gear motor with a new one, both gear motor wires are black; either wire may go to black or white wire from power supply.

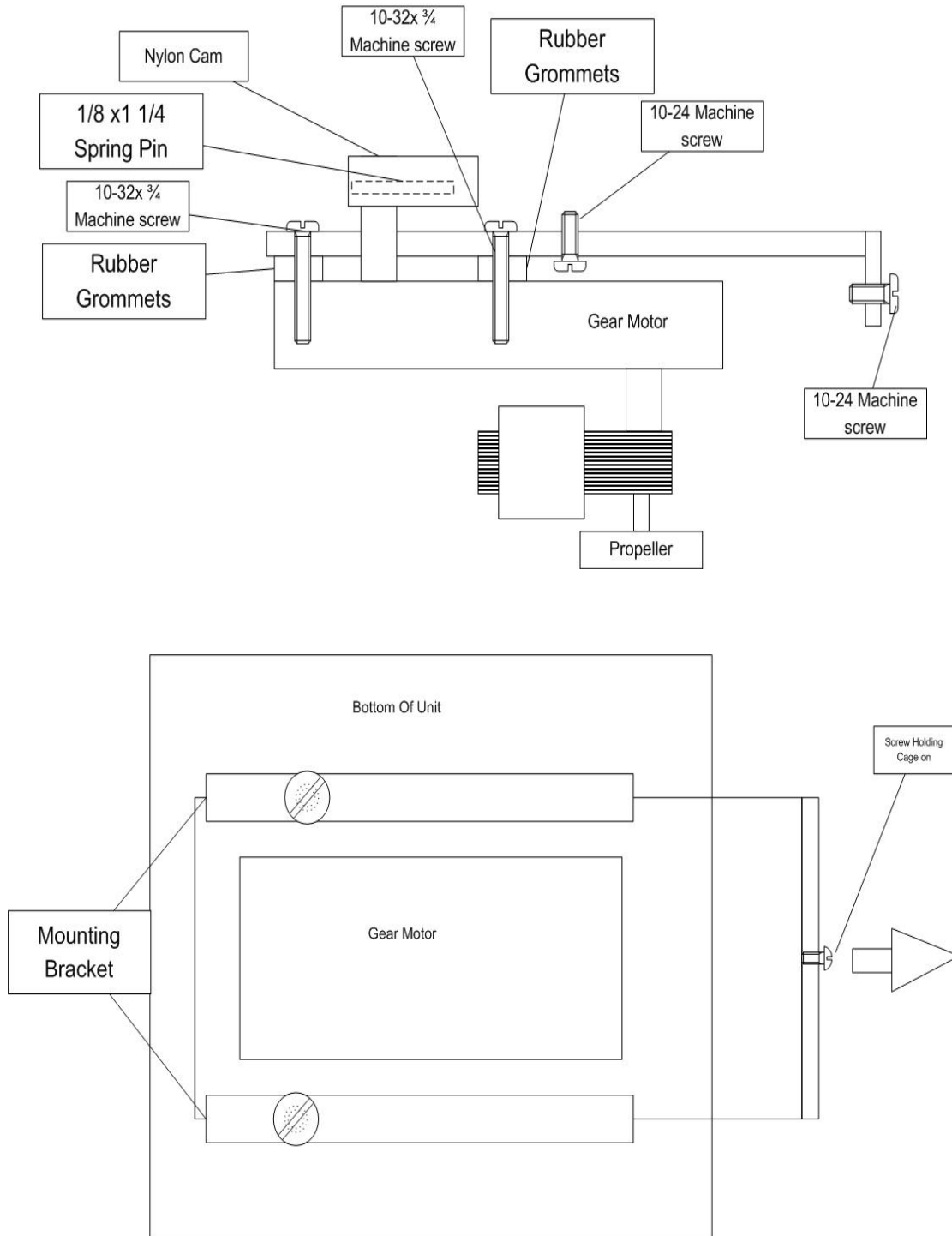

**K-2 / K-6 Flat grate TROUBLE SHOOTING GUIDE**

FIRE GOES OUT See page 11 and 12 (Timer)

COAL KLINKERING OR FUSING TOGETHER See page 9 Diagram (1) & (2)

STOKER UNIT DOESN'T FEED COAL See page 10 (Pusher Bar)

PUSHER BAR IS NOT MOVING STRAIGHT See page 10 (Pusher Bar)

CIRCULATOR RUNS TOO OFTEN See Page 18

THERMOSTAT CALLS FOR HEAT, but circulating pump too long (See Page 5 Diagram 1).

FIRE IS LIT, BUT NOT ENOUGH HEAT

If gear motor only runs short cycles, timer is working. When thermostat calls for heat, gear motor should run steady. If gear motor is running steady, but fire is small, increase coal feed. (See page 10).

If gear motor is not running steady, check for loose wire in Thermostat or in Relay. Check for broken thermostat wire between thermostat and Relay.

GEAR MOTOR RUNS CONSTANTLY MAKING TOO MUCH HEAT

Gear motor can only be activated by thermostat or timer. Remove thermostat wires from T.T. terminals in triple aquastat, if gear motor shuts off, replace thermostat wire or Thermostat. Check timer to see if yellow wheel is turning, if not replace timer motor. Check timer switch. (See page 19)

BIG FIRE BUT NOT MUCH HEAT

Fan blades on combustion motor dirty. Brush off.

Accumulated fly ash under grate. Remove combustion motor and clean under grate.

Holes blocked in grate. Open holes with 1/8 center punch (See Page 9 Diagram (1)).

TO CLEAN UNDER OR REPLACE GRATE See Page 9

NYLON CAM MELTS

## K-2 and K-6 Flat Grate with 6 Inch Stack

Under normal operating conditions, nylon cam will not melt. Melting of nylon cam can only be caused by a draft problem.

A blockage in chimney, chimney connector, stove pipe, or stove. Inspect and clean.

Or excessive draft, caused by high chimney, large flue, or high winds. Clean and adjust barometric damper. (Set barometric damper with a draft gauge to obtain a draft reading of -.02 to -.03, See Page 4 Draft Check)

### TO ORDER PARTS

Find the metal 1 ½" x 3" Keystoker label fastened to stoker unit body, near gear motor. The four or five digit number will be required to get proper replacement parts from your dealer.

### **SAFETY**

THE BURNING OF ALL FOSSIL FUELS GENERATES CARBON MONOXIDE GASES. CARBON MONOXIDE GASES ARE TOXIC, CAN CAUSE SICKNESS OR BE FATAL.

To prevent toxic carbon monoxide gases from entering the home, certain precautions must be taken.

Ash tub must be emptied on a regular basis to prevent ashes from overflowing into ash pit area. Excessive ash accumulation may impede air flow to chimney, preventing gases to be drawn up chimney.

Fire door and ash door must be kept closed at all times during normal operation.

It is necessary to keep coal in hopper while stove is in operation.

In most applications it is sufficient to clean stove and stove pipe twice during heating season. However, under extreme weather conditions, or high demand on stove running periods, the stove and stove pipe may need more frequent cleaning. Clean as often as necessary.

### **CAUTION: ASH PAN IS HOT-Always Use Gloves to Remove Ash Pan**

Before removing ash pan, turn switch off, or pull power cord plug from 110V outlet. Open ash door. Use a good pair of gloves, to remove ash pan. Place filled ash pan on a non-combustible surface. Slide an empty ash pan into stove. Close ash door. Turn switch on or plug power cord back into 110V outlet. home. A 4" tee may also be used in place of a 4" elbow. This will allow the bottom of tee to be used as a collection point (out of the flow of exhaust gases) providing an easier access for cleaning and less chance for restriction or blockage.



# TROUBLE SHOOTING HINTS

PROBLEM	POSSIBLE CAUSE	REMEDY
Stoker doesn't run	Main circuit breaker tripped	Reset
	Main fuse blown	Replace
	Fuse on stoker blown	Replace
	Lo water level	Fill boiler to proper water level
Gear motor stops	Obstruction in throat of stoker	Empty hopper and clear
	Feed mechanism tight or corroded	Empty hopper and free-soaking with penetrating oil-Use dry coal to prevent reoccurrence.
	Motor or gear motor defective	Replace
Pressure fluctuates and water out relief valve	Expansion tank full of water	Drain – Close valve in pipe that goes from expansion tank to boiler. Drain tank dry. Close drain in expansion tank. Open valve in pipe to expansion tank. Put water pressure in boiler up to 12 to 15 lbs.
	Relief valve defective	

## Triple Aquastat with High and Low Limit

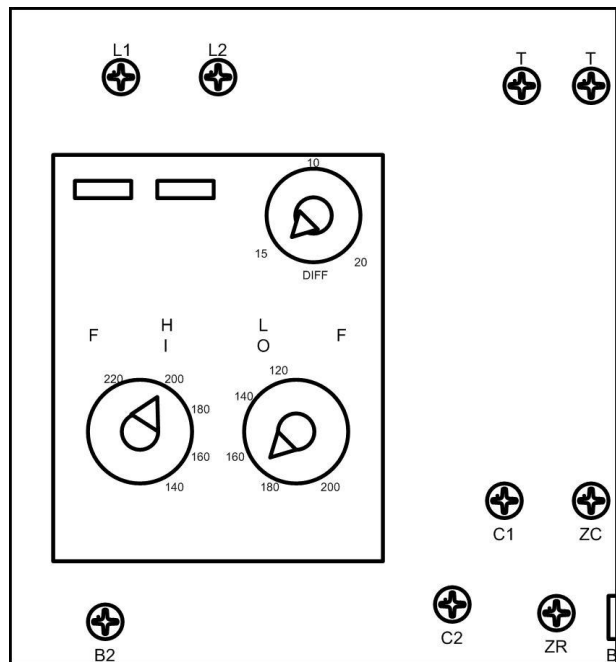

# TROUBLE SHOOTING HINTS

PROBLEM	POSSIBLE CAUSE	REMEDY						
Stoker runs but doesn't feed coal	Feed nut backed off too far.  Obstruction in throat of stoker.  Feed mechanism tight or corroded  Broken nylon screws  Defective gearbox	Increase feed-see preceding instructions.  Empty hopper and remove obstruction.  Empty hopper –free- use dry coal to prevent reoccurrence.  Replace  Replace						
Circulator doesn't run	Lo limit setting in Triple aquastat too high  Boiler not up to temperature.  Fire bed too small  Defective thermostat  Circulator defective	<table border="0"> <tr> <td>Summer</td> <td>Winter</td> </tr> <tr> <td>Set Lo at 140</td> <td>160</td> </tr> <tr> <td>Set Hi at 160</td> <td>180</td> </tr> </table> Increase coal feed to get bigger fire.  Replace  Replace	Summer	Winter	Set Lo at 140	160	Set Hi at 160	180
Summer	Winter							
Set Lo at 140	160							
Set Hi at 160	180							
Circulator runs but no heat	Air in lines Pressure low.	Purge air from radiation Increase – 12 to 15 lbs. Check for leaks if pressure drops frequently.						

K-2 and K-6 Flat Grate with 6 Inch Stack

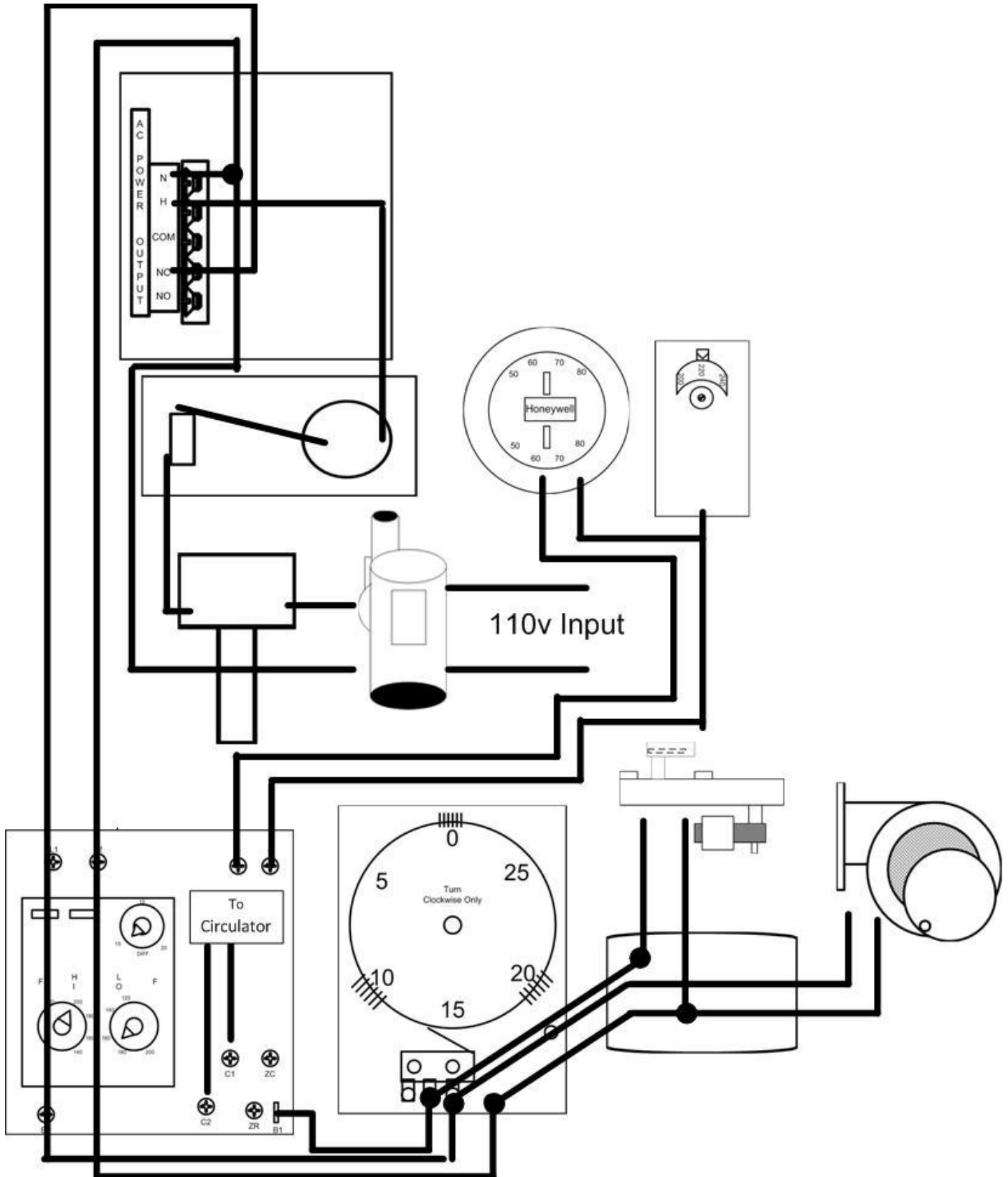

# Checklist

Charcoal  
Thermostat  
Relief Valve  
Pressure/Temperature Gauge  
4009B with Well  
Fire Door  
Draft Regulator  
Control  
Instructions  
Operating Manual  
Warranty Card  
Low Water Cutoff Well  
2 – 5/16 Nuts  
2 Hopper Washers  
4 – 3/8 Washers  
Spring Handle  
Carbon Monoxide Detector